



WARNING: Please take the time to read through the ENTIRE instructions prior to starting any work. Not following the instructions will invalidate the warranty.

TOOLS REQUIRED:

- 2" x 4" Lumber
- #8 x 1 5/8" Truss Drywall Screws
- Crow Bar
- Drywall Saw
- Drywall Screws
- Hammer
- Level/Plumb Bob/Square
- Plywood/Drywall
- Reciprocating Saw
- Roofing Material/Shingles
- Roofing Felt
- Safety Glasses
- Sealant & Gun
- Tape Measure
- Utility Knife

Self-Flashing Polycarbonate Skylight

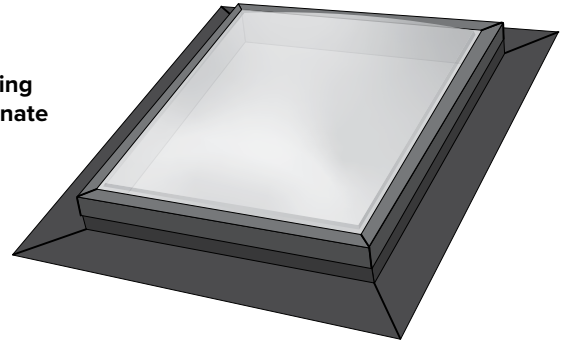

IMPORTANT PRECAUTIONS:

Skylights are subject to condensation caused by warm moist air rising from the room below. Insulate the light shaft and other areas surrounding skylight to minimize condensation. In some cases, the light shaft may require special ventilators to remove moist air.

- Be sure the skylight remains adequately supported by the roof if either headers or rafters are setback from edge of the rough opening to prevent roof failure and possible injury.

IMPORTANT WARNINGS:

- Do not cut roof trusses. If trusses must be cut, obtain expert guidance from an architect, structural engineer, or roof truss manufacturer. Work from professionally prepared plans.
- Support the roof with braces before cutting rafters, to prevent roof failure which can cause severe injury and structural damage.
- Obtain guidance from an architect or structural engineer, if more than one rafter is cut to prevent roof failure and possible injury.

IMPORTANT SAFETY NOTES:

- Remove nails and other obstructions to prevent them from being thrown while cutting.
- Be sure electrical wires, pipes, and other building components will not be cut or damaged.
- Wear eye protection and follow safety procedures recommended by the saw manufacturer.
- To avoid injury or damage, use blocks or bracing to prevent cutout section from dropping as it is freed.
- Stay clear of cutting area while sawing; be especially careful of hand placement and falling debris on the interior, underneath the work area.

STANDARD SKYLIGHT SIZING CHART

MODEL SIZE	ROUGH OPENING width x length
1414	14.5" x 14.5"
1422	14.5" x 22.5"
1430	14.5" x 30.5"
1446	14.5" x 46.5"
2222	22.5" x 22.5"
2230	22.5" x 30.5"
2246	22.5" x 46.5"
2269	22.5" x 69.5"
3030	30.5" x 30.5"
3046	30.5" x 46.5"
4646	46.5" x 46.5"

This information is supplied in good faith, without charge and recommendation as to its use. No guarantee of results of any use of the information is to be implied, since the conditions of use are beyond our control.

STEP 1

Choose location for skylight installation. Consider natural light, sunshine and shade for overhead and eye-level placement. To optimize the view, the eye level is from 56" to 67" from the floor. Also consider attic obstructions including HVAC duct, gas/water pipes, and electrical devices.

INSTALLATION CROSS SECTION:

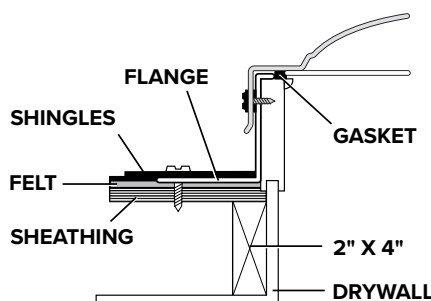

STEP 2

Determine type of light shaft desired.

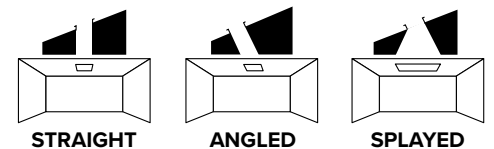

STEP 3

Determine header setback (optional).

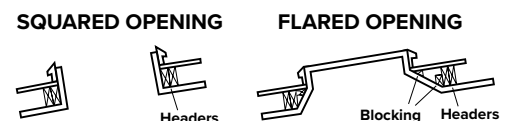

BUILDING LIGHT TUNNEL

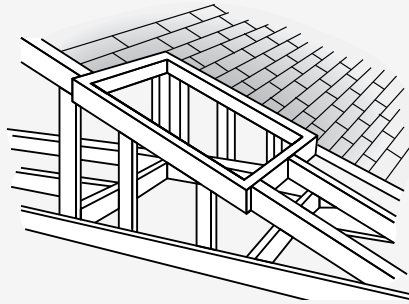

In structures that have a space between the ceiling and the roof such as an attic or crawl space, a light tunnel must be built. Nailers of 2" x 4" must be used to frame the opening between the roof header and the ceiling header. These will be used for attaching the finishing material, i.e., drywall, wall board, plywood, etc. The light tunnel should be wrapped with insulation for optimum performance. Select desired shaft and frame accordingly.

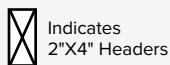

Indicates
2"X4" Headers

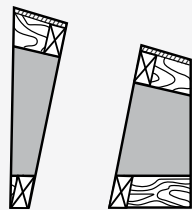

ANGLED SHAFT

An angled shaft is required when the skylight cannot be positioned directly above the area to be lighted because of existing pipes, electrical wiring, duct work, or roof limitations such as ridges or valleys. Locate the skylight as close to the desired areas as possible and then build the shaft on an angle to the ceiling opening.

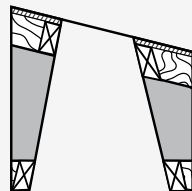

SPLAYED SHAFT

The splayed shaft is used to permit the greatest light exposure. This is done by making the ceiling opening larger than the roof opening.

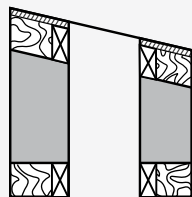

STRAIGHT SHAFT

A straight shaft from the roof to ceiling can be used. If the roof is flat, the ceiling and roof openings will be the same dimension. With a pitched roof, the ceiling opening will be slightly smaller than the roof opening.

BUILT-UP ROOFS:

(Use SFG 4" model or check local building codes.)

Carefully apply hot pitch or sealant to the surrounding area and base of curb flange. Cover with rock.

BARREL TILE INSTRUCTIONS:

(Use 4" or 6" curb. Check local building codes.)

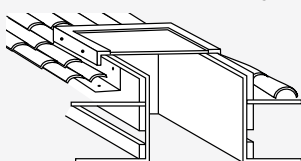

After locating skylight position on roof, carefully remove barrel tiles and cut rough opening. Center skylight over rough opening, and secure into place using pre-punched holes in flange. Mop in roll roofing over flashing. Cement tiles on roof around curb and skylight assembly. Finish inside curb with drywall and trim.

STEP 4

Mark the planned location on ceiling. Ensure it is square and cut opening in ceiling with a drywall saw.

IMPORTANT: Rough openings should be made to the suggested sizes (see standard sizing chart).

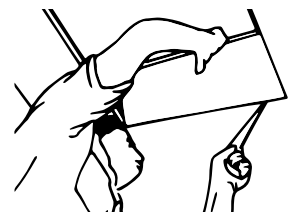

STEP 5

In the attic, using a plumb bob or level, plumb up from the four corners in the ceiling to the underside of the roof sheathing. Mark them by driving nails through the roof.

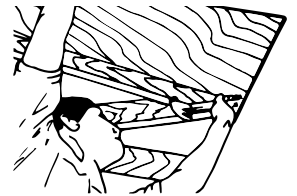

STEP 6

Remove approximately 10" of the surrounding roofing material and nails from planned location. Mark perimeter of rough opening and cut through felt paper and roof decking.

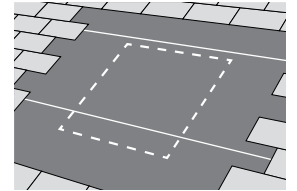

STEP 7

Install headers based on size of opening and rafter pattern.

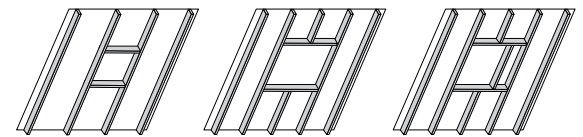

Opening fits
between rafters,
use single headers

One rafter cut,
use double
headers

Opening ends short
of the rafter, install
jack rafter

STEP 8

Frame out the inside of the roof opening with double headers at the top and bottom of the opening. Butt 2x4's against the outside of the truss or rafters that frame the opening, and nail into place to provide extra stability when mounting the skylight. Any rafter or truss that runs through the skylight opening must be cut to meet local building codes.

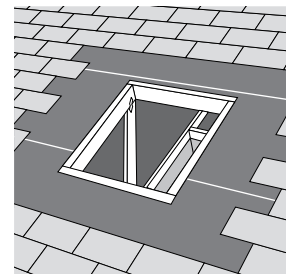

IMPORTANT NOTE: If the opening is too big, fill it in with the proper lumber to the suggested rough opening size or smaller.

STEP 9

Apply a liberal amount of sealant to surrounding roof opening. Carefully center the skylight into place and push down to ensure a good seal. Using pre-punched holes in flange, secure to roof surface using #8 x 1 5/8" Truss Head Drywall Screws. (See next page for sealant info.)

HSFAW Skylights: Use #10 x 1 5/8" provided mounting screws.

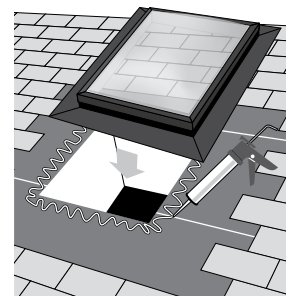

STEP 10

Apply sealant to cover each hole, fastener and the outside of skylight flange. For additional weather-proofing, wrap the entire perimeter of the flange using installation flashing tape (optional). Replace roofing material. On pitched roofs, replace shingles covering high side of skylight flange.

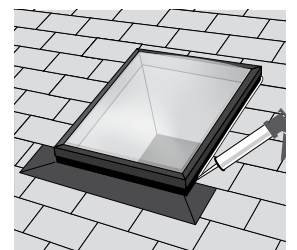

SUGGESTED SEALANTS

BUTYL SYNTHETIC RUBBER SEALANTS:

- Tremco, Inc. TremPro JS-773 Butyl Sealant Off White
- Henkle Corp. PL Ultimate Hybrid Sealant White
- Loctite Loctite Power Grab All Purpose Clear
- Liquid Nails - MACCO Silicone Premium Universal Sealant Clear

DO NOT put roofing mastic or hot steep asphalt on the transparent plastic skylight. For best results use a high grade sealant material that has a long life. Low grade sealants should not be used.

DO NOT USE GEOCEL 2300. Check with the sealant manufacturer or dealer for compatibility with polycarbonate plastic.

NOTE: Compatible glazing tapes and ice/water shields may be used in place of sealants.

CLEANING AND MAINTENANCE

When you clean your Polycarbonate skylight, use chemically compatible cleaners to ensure continued performance and product life. Your skylight(s) have a UV protective coating and are constructed of polycarbonate sheets.

1. Wash skylight with mild soap or cleaning agent and lukewarm water. Rinse with clear water.
2. Use soft cloth or sponge when gently washing (DO NOT SCRUB), and dry gently and thoroughly with chamois or cellulose sponge.

Some Compatible Cleaning Materials:

- Formula 409® (Clorox Company trademark)
- VM&P grade Naphtha
- Joy® (Proctor & Gamble trademark)
- Windex with Ammonia D® (Drackett Products trademark)
- Top Job® (Proctor & Gamble trademark)

Some Incompatible Cleaning Agents:

- Lysol® (Sterling Drugs trademark)
- Pine Sol® (American Cyanamid trademark)

Fresh Paint, Grease, and Glazing Compound Removal:

Remove above before drying by wiping with a soft cloth saturated with VM&P Naphtha. Then wash as in cleaning instructions.

Label and Sticker Removal:

VM&P Naphtha will generally remove masking and other label adhesives. Wash afterwards as in cleaning instructions. Excessive rubbing or scraping can damage skylight surface.

CAUTIONS: Benzene, gasoline, acetone, or carbon tetrachloride should not be used on our skylights. Use no abrasive or alkaline cleaners. Avoid scraping with razor blades or other instruments. Do not clean skylights in direct sunlight or at elevated temperatures.